

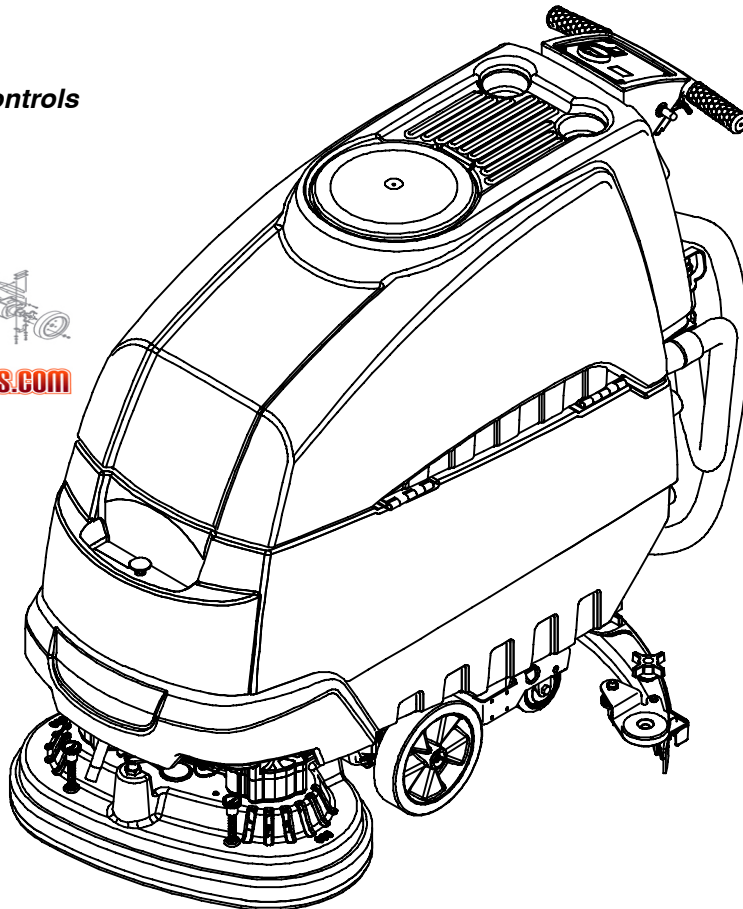

The Safe Scrubbing Alternative®

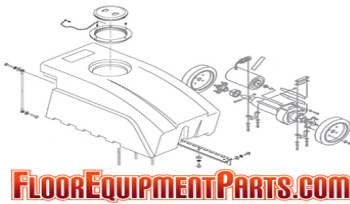

Quick-Train™ Controls



SPEED SCRUB®

AUTOMATIC SCRUBBER

OPERATOR MANUAL



OPERATION

This manual is furnished with each new model. It provides necessary operation and maintenance instructions.

Read this manual completely and understand the machine before operating or servicing it.

A complete illustrated Parts Manual is also furnished with each new model. Use the Parts Manual to order replacement parts. To ensure prompt delivery, follow the "HOW TO ORDER PARTS" instructions printed in the Parts Manual.

This machine will provide excellent service. However, the best results will be obtained at minimum costs if:

- The machine is operated with reasonable care.
- The machine is maintained regularly - per the machine maintenance instructions provided.
- The machine is maintained with manufacturer supplied or equivalent parts.



PROTECT THE ENVIRONMENT

Please dispose of packaging materials, old machine components such as batteries, hazardous fluids, including antifreeze and oil, in an environmentally safe way according to local waste disposal regulations.



Always remember to recycle.

MACHINE DATA

IMPORTANT: To ensure full warranty protection, fill out the attached MACHINE INSTALLATION / WARRANTY REPORT REPLY CARD and return to Tennant within 30 days of purchase.

Please fill out at time of installation for future reference.

Model No. - _____

Serial No. - _____

Machine Options - _____

Sales Rep. - _____

Sales Rep. phone no. - _____

Customer Number - _____

Installation Date - _____

TENNANT Company
PO Box 1452
Minneapolis, MN 55440
Phone: (800) 553-8033 or (763) 513-2850

www.nobles.com

FaST-PAK is a registered United States trademark of Tennant Company.

Specifications and parts are subject to change without notice.

Copyright © 2006, 2007, 2008 TENNANT COMPANY, Printed in U.S.A.
All rights reserved.

TABLE OF CONTENTS

SAFETY PRECAUTIONS	4	CHARGING BATTERIES	18
SAFETY LABELS	5	BATTERY CHARGER SPECIFICATIONS ...	18
MACHINE COMPONENTS	6	ON-BOARD BATTERY	
CONTROL PANEL COMPONENTS	7	CHARGER SETTINGS	18
MACHINE INSTALLATION	8	USING THE ON-BOARD	
UNCRATING MACHINE	8	BATTERY CHARGER	18
INSTALLING BATTERIES	8	ON-BOARD BATTERY CHARGER	
HOW THE MACHINE WORKS	9	ERROR CODES	19
BRUSH AND PAD INFORMATION	9	USING AN OFF-BOARD	
MACHINE SETUP	9	BATTERY CHARGER	20
ATTACHING SQUEEGEE ASSEMBLY	9	ADJUSTING SCRUB HEAD BRUSHES	20
INSTALLING BRUSHES/pads	10	DISK MODEL	20
INSTALLING FaST-PAK		CYLINDRICAL BRUSH MODEL	21
CARTON (FaST Model)	11	MACHINE MAINTENANCE	22
FILLING SOLUTION TANK	12	DAILY MAINTENANCE (After Every Use) ...	22
ADJUSTING control console HEIGHT	12	MONTHLY MAINTENANCE	24
MACHINE OPERATION	12	BATTERY MAINTENANCE	25
PRE-OPERATION CHECKS	12	SQUEEGEE BLADES	26
STARTING THE MACHINE	12	Replacing Squeegee Blades:	26
EMERGENCY STOPPING	14	MOTOR MAINTENANCE	26
WHILE OPERATING MACHINE	14	FaST SYSTEM MAINTENANCE	27
BATTERY METER	15	ec-H2O MODULE FLUSH PROCEDURE ...	27
HOUR METER	15	JACKING UP MACHINE	28
CIRCUIT BREAKERS / FUSES	15	TRANSPORTING MACHINE	28
OFF-AISLE WAND	16	STORING MACHINE	29
Preparing Machine for Off-Aisle		FREEZE PROTECTION	29
Wand Scrubbing:	16	RECOMMENDED STOCK ITEMS	30
Operating the Off-Aisle Wand:	16	TROUBLESHOOTING	31
DRAINING AND CLEANING TANKS	17	TROUBLESHOOTING - Continued	32
DRAINING RECOVERY TANK	17	TROUBLESHOOTING - Continued	33
DRAINING SOLUTION TANK	17	BATTERY METER LED FAULT CODES	33
		MACHINE SPECIFICATIONS	34
		MACHINE DIMENSIONS	35

SAFETY PRECAUTIONS

This machine is intended for industrial and commercial use. It is designed exclusively to scrub hard floors in an indoor environment and is not constructed for any other use. Only use recommended pads, brushes and commercially approved floor cleaners intended for machine application.

The following warning alert symbol and the "FOR SAFETY" heading are used throughout this manual as indicated in their description:

 **WARNING:** To warn of hazards or unsafe practices which could result in severe personal injury or death.

FOR SAFETY: To identify actions which must be followed for safe operation of equipment.

The following safety precautions signal potentially dangerous conditions to the operator or equipment. All operators must read, understand and practice them.

 **WARNING:** Fire Or Explosion Hazard

- Never Use Flammable Liquids Or Operate Machine In Or Near Flammable Liquids, Vapors Or Combustible Dusts.

This machine is not equipped with explosion proof motors. The electric motors will spark upon start up and during operation which could cause a flash fire or explosion if machine is used in an area where flammable vapors/liquids or combustible dusts are present.

- Do Not Pick Up Flammable Materials Or Reactive Metals.
- Batteries Emit Hydrogen Gas. Keep Sparks And Open Flame Away. Keep Battery Compartment Open When Charging.

 **WARNING:** Electrical Hazard

- Disconnect Battery Cables and Charger Plug Before Servicing Machine.
- Do Not Charge Batteries with Damaged Power Supply Cord. Do Not Modify Plug.

If the charger supply cord is damaged or broken, it must be replaced by the manufacturer or its service agent or a similarly qualified person in order to avoid a hazard.

 **WARNING:** Spinning Brush. Keep Hands Away. Turn Off Power Before Working On Machine.

FOR SAFETY:

1. Do not operate machine:
 - With flammable liquids or near flammable vapors as an explosion or flash fire may occur.
 - Unless trained and authorized.
 - Unless operator manual is read and understood.
 - If not in proper operating condition.
2. Before starting machine:
 - Make sure all safety devices are in place and operate properly.
3. When using machine:
 - Go slow on inclines and slippery surfaces.
 - Wear non-slip shoes.
 - Reduce speed when turning.
 - Report machine damage or faulty operation immediately.
 - Never allow children to play on or around.
 - Follow mixing and handling instructions on chemical containers.
 - Do not operate on inclines that exceed 5% (3°).
4. Before leaving or servicing machine:
 - Stop on level surface.
 - Turn off machine.
 - Set parking brake, if equipped.
 - Remove key.
5. When servicing machine:
 - Avoid moving parts. Do not wear loose jackets, shirts, or sleeves.
 - Disconnect battery cables and charger plug before working on machine.
 - Wear protective gloves and eye protection when handling batteries or battery cables.
 - Avoid contact with battery acid.
 - Wear protective gloves and eye protection when handling white vinegar.
 - Do not power spray or hose off machine. Electrical malfunction may occur.
 - Jack machine up at designated locations only (See JACKING UP MACHINE).
 - Use hoist or jack that will support machine weight.
 - Use manufacturer supplied or approved replacement parts.
 - All repairs must be performed by a qualified service person.
 - Do not modify the machine from its original design.

6. When loading/unloading machine onto/off truck or trailer:
- Drain tanks before loading.
 - Use a ramp that can support the machine weight and person loading it. Do not exceed a 11° ramp incline at a ramp length of 12 ft (3.7m).

- Turn machine off.
- Put scrub head in the lowered position.
- Block machine wheels.
- Use tie-down straps to secure machine.
- Set parking brake, if equipped.

SAFETY LABELS

The safety labels appear on the machine in the locations indicated. Replace labels if they are missing or become damaged or illegible.

WARNING LABEL -

Located on recovery tank cover.



BATTERY CHARGE LABEL -

Located on bottom side of recovery tank.

⚠ WARNING: Fire Or Explosion Hazard. Batteries Emit Hydrogen Gas. Keep Sparks And Open Flame Away. Keep Battery Compartment Open When Charging.



SPINNING BRUSH LABEL -

Located on scrub head

⚠ WARNING: Spinning Brush. Keep Hands Away. Turn Off Power Before Working On Machine.

OPERATION

MACHINE COMPONENTS

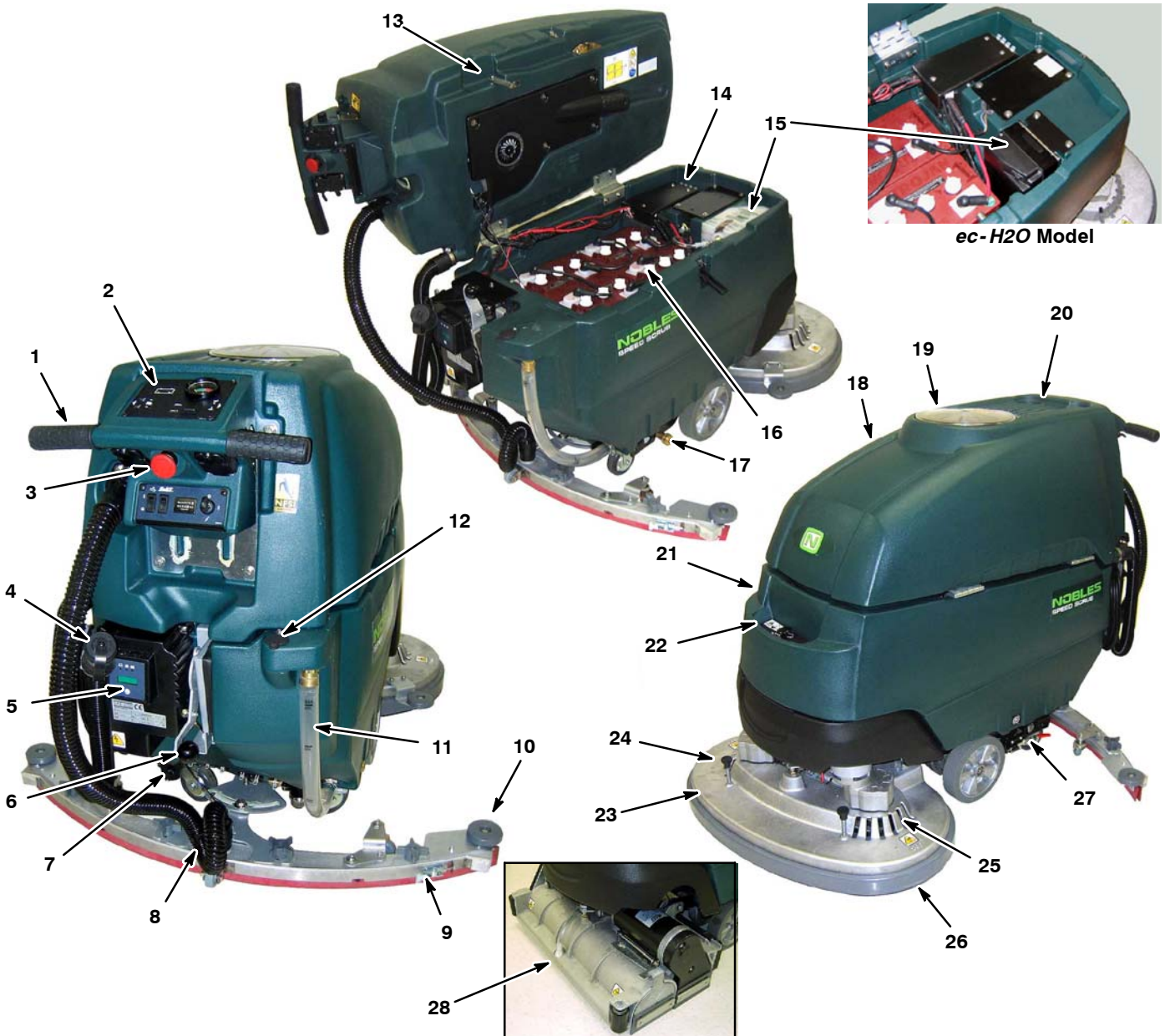

1. Adjustable Control Console
2. Control Panel
3. Emergency Stop Button (option)
4. Recovery Tank Drain Hose
5. On-board Battery Charger
6. Squeegee Lift Lever
7. Solution Flow Control Knob
8. Squeegee Vacuum Hose
9. Squeegee Assembly
10. Wall Rollers
11. Solution Tank Level/Drain Hose
12. Rear Fill Port
13. Recovery Tank Support Stand
14. Circuit Breaker Panel

15. FaST-PAK Carton Compartment (FaST Model)
ec-H2O System Module (ec-H2O Model)
16. Batteries
17. Off-Aisle Wand Solution Hose Coupler
18. Recovery Tank
19. Recovery Tank Cover
20. Cup Holders
21. Solution Tank
22. Front Fill Port
23. Disk Scrub Head
24. Pad Release Plunger
25. Pad Driver Window
26. Scrub Head Skirt
27. Parking Brake (option)
28. Cylindrical Brush Scrub Head

CONTROL PANEL COMPONENTS

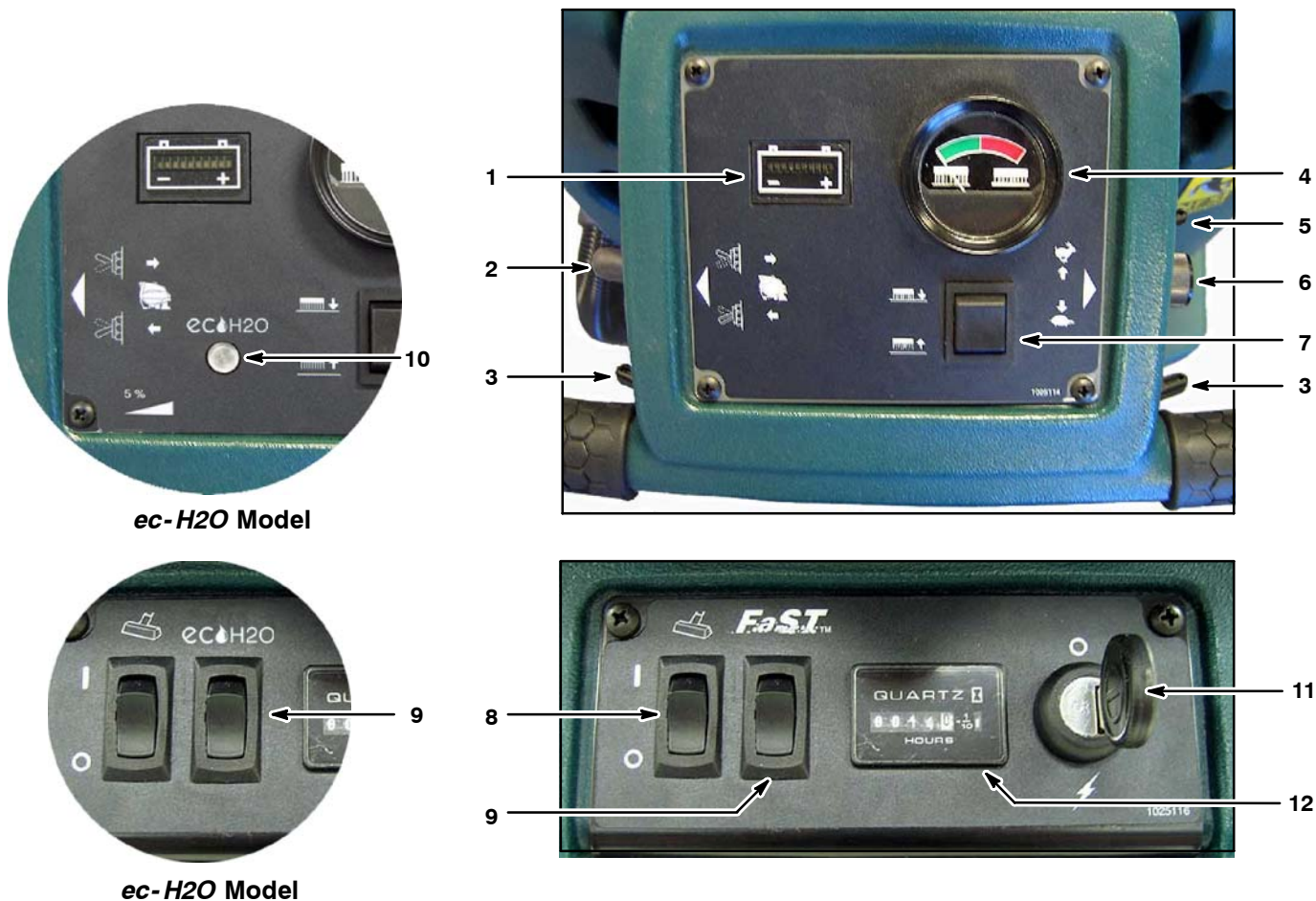

ec-H2O Model

ec-H2O Model

- | | |
|---|--|
| <ul style="list-style-type: none"> 1. Battery Meter 2. Reverse Trigger 3. Start Triggers 4. Brush Pressure Meter 5. Control Console Height Adjustment Lever 6. Speed Control Knob | <ul style="list-style-type: none"> 7. Brush Pressure Switch 8. Off-Aisle Wand on/off Switch (option) 9. FaST System on/off Switch (FaST Model)
<i>ec-H2O system on/off switch (ec-H2O Model)</i> 10. <i>ec-H2O system indicator light (ec-H2O Model)</i> 11. Main Power on/off Key Switch 12. Hour Meter |
|---|--|

OPERATION

MACHINE INSTALLATION

UNCRATING MACHINE

1. Carefully check the shipping crate for signs of damage. Report damage at once to carrier.
2. Check the contents list. Contact distributor for missing items.

Contents:

- 4-6 V Batteries-Optional
- 3-Battery Cable Jumpers
- Battery Tray
- 1-FaST-PAK 365 Concentrate-(FaST model)
- Squeegee Assembly
- 2-Pad drivers (Disk Model)
- 2-Brushes (Cylindrical Brush Model)

3. To uncrate your machine, remove the shipping hardware and straps that secure the machine to the pallet. Carefully back machine down ramp.

ATTENTION: Do not roll machine off pallet unless a ramp is used, machine damage may occur.

ATTENTION: To prevent possible machine damage, install batteries *after* removing machine from shipping pallet.

INSTALLING BATTERIES

⚠ WARNING: Fire Or Explosion Hazard. Batteries Emit Hydrogen Gas. Keep Sparks And Open Flame Away. Keep Battery Hood Open When Charging.

FOR SAFETY: When installing batteries, wear protective gloves and eye protection. Avoid contact with battery acid.

Battery Specifications:

Four 6 volt, 235A/20h deep cycle batteries. Maximum battery dimensions:
7.5 in / 190 mm W x 10.8 in / 275 mm L x 11.2 in / 284 mm H.

1. Park the machine on a level surface, remove the key and set the parking brake, if equipped.

2. Carefully install the batteries into the battery compartment tray (Figure 1). Arrange the battery posts as shown (Figure 2).



FIG. 1

3. Connect the battery cables to the battery posts as shown (Figure 2), RED TO POSITIVE (+) and BLACK TO NEGATIVE (-).

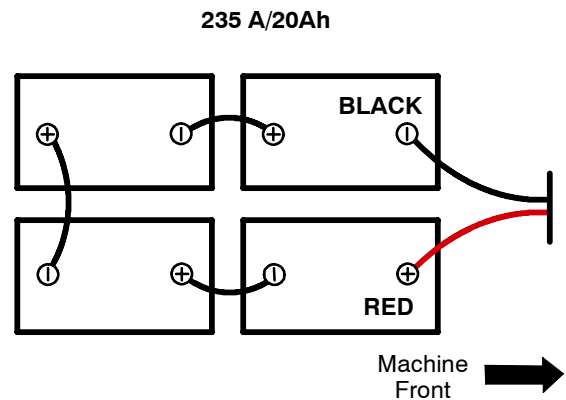

FIG. 2

IMPORTANT: If your machine is equipped with the on-board battery charger, make sure that the charger is properly set for your battery type before charging (See ON-BOARD CHARGER SETTINGS).

HOW THE MACHINE WORKS

Conventional Scrubbing:

Water and detergent from the solution tank flow to the floor through a solution valve. The brushes use the detergent and water to scrub the floor clean. As the machine moves forward, the squeegee wipes the dirty solution from the floor into the recovery tank.

Foam Scrubbing (FaST Model):

(FaST-Foam activated Scrubbing Technology)

Unlike conventional scrubbing, the FaST system injects the FaST-PAK concentrate formula with a small amount of water and air onto the floor. The mixture creates a large volume of expanded wet foam for the brush to scrub the floor clean. As the machine moves forward, the foam collapses and the squeegee recovers the dirty solution into the recovery tank leaving the floor clean, dry and slip free.

ec-H₂O Scrubbing (ec-H₂O Model):

(ec-H₂O-electrically converted water)

Normal water passes through a module where it is oxygenated and charged with an electric current. The electrically converted water changes into a blended acidic and alkaline solution forming a neutral pH cleaner. The converted water attacks the dirt, breaks it into smaller particles, and pulls it off the floor surface allowing the machine to easily scrub away the suspended soil. The converted water then returns to normal water in the recovery tank.

BRUSH AND PAD INFORMATION

For best cleaning results use the appropriate brush type for your cleaning application. Refer to the Parts manual for part number information.

Polypropylene Bristle Scrub Brush (Black) -

This general purpose polypropylene bristle scrub brush is used for scrubbing lightly compacted soilage. This brush works well for maintaining concrete, wood and grouted tile floors.

Soft Nylon Bristle Scrub Brush (White) -

Recommended for cleaning coated floors without removing finish. Cleans without scuffing.

Super Abrasive Bristle Scrub Brush (Gray) -

Nylon fiber impregnated with abrasive grit to remove stains and soilage. Strong action on any surface. Performs well on buildup, grease, or tire marks.

Polishing Pad (White) -

Used to maintain highly polished or burnished floors.

Buffing Pad (Red) - Used for light duty scrubbing without removing floor finish.

Scrubbing Pad (Blue) - Used for medium to heavy-duty scrubbing. Removes dirt, spills, and scuffs and leaves surface clean and ready for recoating.

Stripping Pad (Brown) - Used for stripping of floor finish to prepare the floor for recoating.

Heavy Duty Stripping Pad (Black) - Used for aggressive stripping of heavy finishes/sealers, or very heavy duty scrubbing.

MACHINE SETUP

ATTACHING SQUEEGEE ASSEMBLY

1. Park the machine on a level surface, remove the key and set the parking brake if equipped.
2. Lift the squeegee lift lever to the upward position (Figure 3).



FIG. 3

3. Mount the squeegee assembly to the squeegee pivot bracket and secure with knobs (Figure 4).



FIG. 4

OPERATION

4. Connect the vacuum hose to the squeegee assembly. Loop the hose as shown using the hose clip provided (Figure 5).

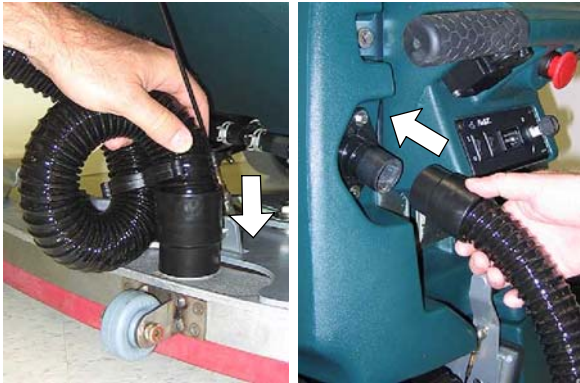

FIG. 5

5. Check the squeegee blades for proper deflection. The blades should deflect as shown (Figure 6).



FIG. 6

6. To adjust the blade deflection, place the squeegee assembly on a level surface and adjust the casters as shown (Figure 7).

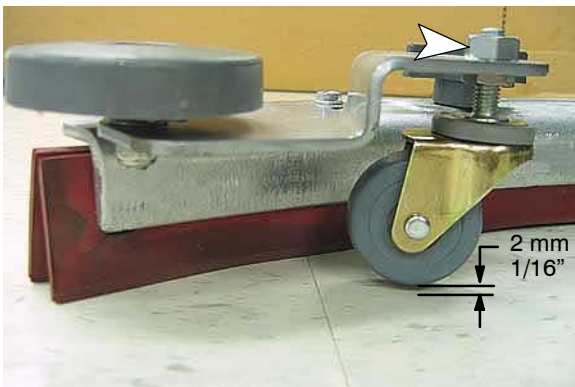

FIG. 7

INSTALLING BRUSHES/PADS

FOR SAFETY: Before installing brushes or pad drivers, stop machine on level surface, remove key and set parking brake if equipped.

Disk Model:

1. Raise scrub head off the floor and remove key.
2. Attach the pad to the pad driver before installing the driver. Secure pad with centerlock (Figure 8).

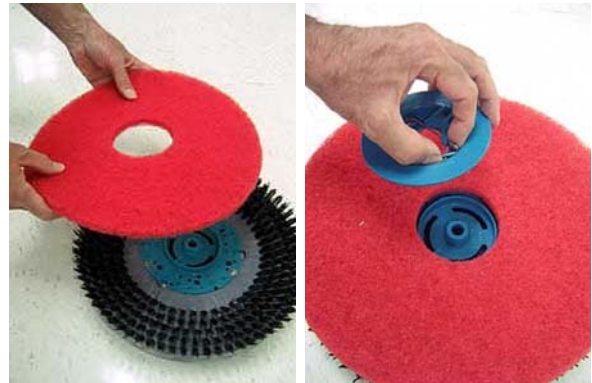

FIG. 8

3. Align the pad driver under the motor hub and push it upward to engage (Figure 9).



FIG. 9

4. To remove the pad driver, raise the scrub head and push the pad release plunger downward (Figure 10).



FIG. 10

5. Check the scrub head to ensure that it is properly adjusted (See ADJUSTING SCRUB HEAD BRUSHES).

Cylindrical Brush Model:

1. Raise scrub head off the floor and remove key.
2. Remove idler plate from scrub head by pressing the spring tab downward (Figure 11).



FIG. 11

3. Attach idler plate to the brush end that has the double row of bristles (Figure 12). Install brush.



FIG. 12

4. Check the brushes to ensure they are properly adjusted (See ADJUSTING SCRUB HEAD BRUSHES).

INSTALLING FaST-PAK CARTON (FaST Model)

ATTENTION: The FaST-PAK Concentrate Formula is specifically designed for the FaST system. NEVER use a substitute. Machine damage may result.

1. Pull out the hose connector from the FaST-PAK carton and remove cap (Figure 13).



FIG. 13

2. Open the battery compartment. Connect the FaST-PAK carton to the supply hose and place carton in compartment (Figure 14). **Make sure the hose does not get pinched.**



FIG. 14

3. When the supply hose is not in use, connect the storage plug to prevent the FaST system from drying out and clogging up the hose. (Figure 15).

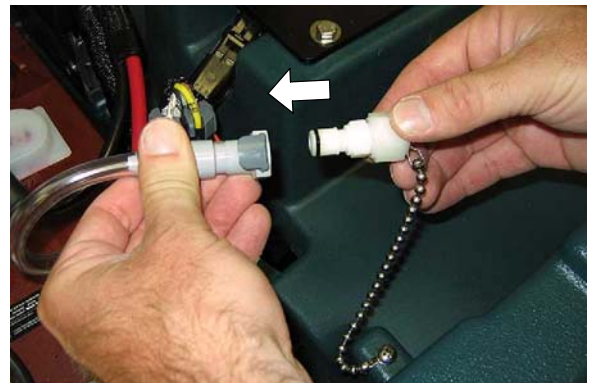

FIG. 15

OPERATION

FILLING SOLUTION TANK

Using a hose or bucket, fill the solution tank to the "MAX 85L" mark (Figure 16).

For Conventional Scrubbing: Use hot water (140°F/60°C maximum). Pour a recommended cleaning detergent into the solution tank according to mixing instructions on the container.

For FaST or ec-H2O Scrubbing: Use cool clean water only (less than 70°F/21°C). Do not add any conventional floor cleaning detergents, system failure may result.

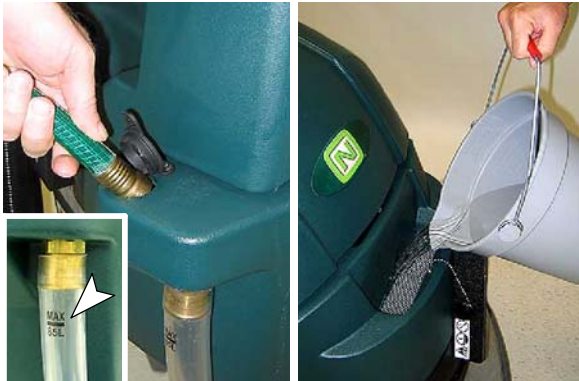

FIG. 16

ATTENTION: For Conventional Scrubbing, only use commercially approved cleaning detergents. Machine damage due to improper detergent usage will void the manufacturer's warranty.

⚠ WARNING: Fire or Explosion Hazard. Never Use Flammable Liquids.

ADJUSTING CONTROL CONSOLE HEIGHT

Pull the control console height adjustment lever and lift or lower the console to a comfortable operating height. Release lever to lock in position (Figure 17).

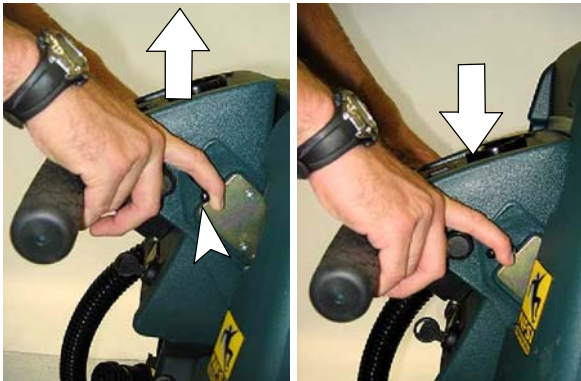

FIG. 17

MACHINE OPERATION

FOR SAFETY: Do not operate machine, unless operator manual is read and understood.

⚠ WARNING: Fire Or Explosion Hazard. Never Operate Machine In Or Near Flammable Liquids, Vapors Or Combustible Dusts.

PRE-OPERATION CHECKS

- Sweep area.
- Check the battery meter.
- Check the brushes/pads for wear.
- Check the squeegee blades for wear and proper adjustment.
- Make sure the recovery tank is empty and the float shut-off screen is installed and clean.
- Check the scrub head skirt for wear.
- For FaST Scrubbing:** Check the FaST-PAK concentrate level.
- For FaST or ec-H2O Scrubbing:** Make sure the solution tank is filled with cool clean water only.
- For FaST or ec-H2O Scrubbing:** Ensure that all conventional cleaning agents are drained and rinsed from solution tank.

STARTING THE MACHINE

1. Release the parking brake if equipped (Figure 18).
2. Turn the key to the on (I) position (Figure 18).



FIG. 18

3. **FaST model:** press the FaST system switch to the on (I) position (Figure 19).

ec-H2O model: press the ec-H2O system switch to the on (I) position (Figure 19).

NOTE: The ec-H2O system indicator light will not turn on until the machine starts scrubbing.

IMPORTANT: NEVER turn the FaST/ec-H2O system switch on when conventional scrubbing. Conventional cleaning detergents/restorers may cause failure to the FaST/ec-H2O solution system. Drain, rinse and refill solution tank with cool clean water before operating the FaST/ec-H2O system.



FIG. 19

4. Lower the squeegee assembly to the floor by lowering the squeegee lift lever (Figure 20).



FIG. 20

5. Lower the scrub head to the floor by pressing the brush pressure button (Figure 21).



FIG. 21

6. Pull the triggers to begin scrubbing (Figure 22). To reverse the machine, simply pull the reverse trigger. Raise squeegee when reversing machine.

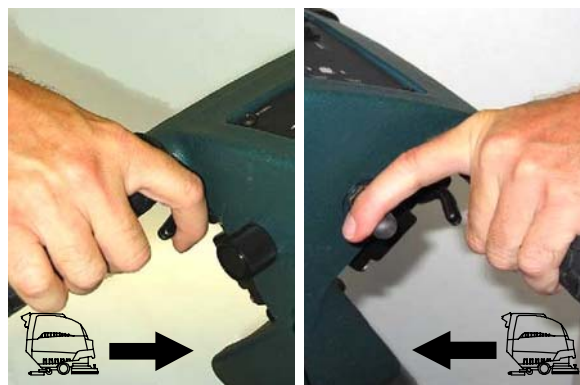

FIG. 22

7. Adjust the speed control knob to a desired scrubbing speed (Figure 23).

NOTE: 148-197 feet / 45-60 meters per minute is the recommended scrubbing speed.



FIG. 23

8. Check the brush pressure meter reading and adjust the pressure if needed (Figure 24). Do not operate the machine in the red zone, floor damage or brush motor overload may result.



FIG. 24

OPERATION

- For conventional scrubbing, adjust the solution flow control knob to a desired flow rate (Figure 25).

NOTE: For the FaST and ec-H2O models, the solution flow rate is fixed and requires no adjustment. The ec-H2O module has optional flow rate settings. If solution flow adjustments are required, contact an Authorized Service Center.



FIG. 25

- To stop scrubbing, release the triggers, raise the scrub head and squeegee and turn the key to the off position.

EMERGENCY STOPPING

Strike the emergency stop button, if equipped, in the event of an emergency (Figure 26). This button shuts off all power to machine. To regain power, turn the button clockwise.



FIG. 26

WHILE OPERATING MACHINE

WARNING: Fire Or Explosion Hazard. Do Not Pick Up Flammable Materials Or Reactive Metals.

- Overlap each scrub path by 2 in / 5 cm.
- Keep the machine moving to prevent damage to floor finish.
- Do not operate the machine on inclines that exceed 5% (3°).
- Conventional scrubbing: Pour a commercially approved foam control solution into the recovery tank if excessive foam appears.

ATTENTION: Do not allow foam to enter the float shut-off screen located in the recovery tank, vacuum motor damage will result. Foam will not activate the float shut-off screen.

- For heavily soiled areas, use the double scrubbing method. First scrub the area with the squeegee up, let solution set for 3-5 minutes, then scrub the area a second time with squeegee down.
- When leaving the machine unattended, remove the key and set the parking brake, if equipped.
- If the machine detects a fault, the battery meter will blink a fault code (See BATTERY METER LED FAULT CODES).
- ec-H2O Model:** If an alarm sounds and the ec-H2O system indicator light begins to blink red, the ec-H2O module must be flushed to resume ec-H2O operation (See ec-H2O MODULE FLUSH PROCEDURE) (Figure 27).

NOTE: When the alarm sounds and the light blinks red, the machine will bypass the ec-H2O system. To continue scrubbing, turn the ec-H2O switch off and change over to conventional scrubbing.

ATTENTION: (ec-H2O model) Do not allow solution tank to run dry. ec-H2O module failure may result if operated without water for an extended period.



FIG. 27

ec-H2O SYSTEM INDICATOR LIGHT CODE	CONDITION
Solid green	Normal operation
Blinking red	Flush ec-H2O module
Solid red	Contact Service Center

BATTERY METER

The battery meter displays the charge level of the batteries (Figure 28). When the batteries are fully charged, all indicator lights will glow. As the batteries discharge, the indicator lights will begin to go out from right to left.

When the discharge level reaches the first red light (Figure 28), stop scrubbing and recharge the batteries. If you continue to operate the machine beyond the first red light, the scrubbing function will automatically shut off when the last red light begins to blink. This protects the batteries from total discharge. Drive the machine to the charging area and recharge the batteries immediately.

NOTE: The battery meter will also display machine fault codes. If a fault is detected the LED bars will flash specific fault codes (See BATTERY METER LED FAULT CODES).

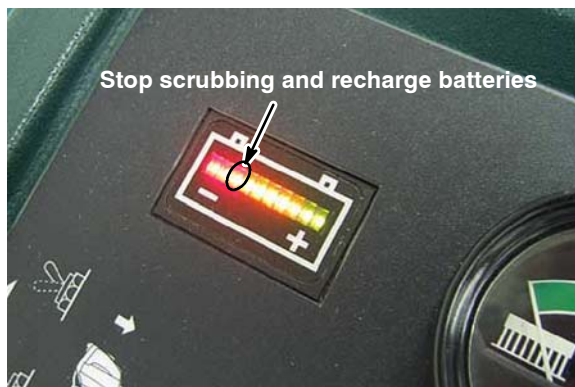

FIG. 28

HOUR METER

The hour meter records the number of total hours the brush motors have been powered on. Use the hour meter to determine when to perform recommended maintenance procedures and to record service history (Figure 30). See MACHINE MAINTENANCE.



FIG. 29

CIRCUIT BREAKERS / FUSES

The machine is equipped with four resettable circuit breakers and four fuses to protect the machine from damage. If a breaker should trip, determine the cause, allow the motor to cool then manually reset the circuit breaker button. The circuit breaker panel is located near the battery compartment (Figure 30). The fuses are located inside the circuit breaker box. When replacing a fuse never substitute a higher Amp rated fuse than specified.

CIRCUIT BREAKERS:

- 10 A - Main (A)
- 25 A - Vacuum motor (B)
- 25 A - Left brush motor (C)
- 25 A - Right brush motor (D)

FUSES:

- 100 A - Main
- 30 A - Propel motor
- 7.5 A - FaST system
- 7.5 A - Off-aisle wand pump (located in control console)

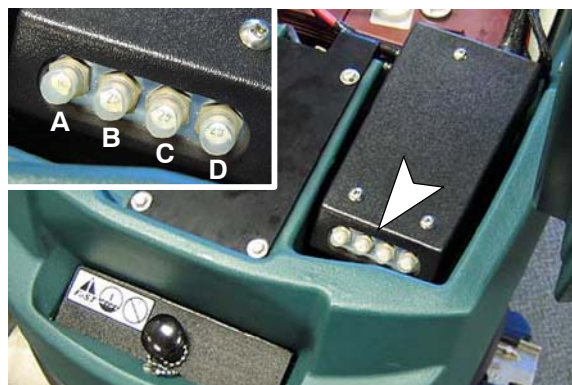

FIG. 30

OPERATION

OFF-AISLE WAND

If your machine is equipped with the off-aisle wand option, this allows you to scrub areas where the machine is unable to reach.

Preparing Machine for Off-Aisle Wand Scrubbing:

1. Park the machine on a level surface, turn key off and set parking brake if equipped.
2. Connect the solution hose to the coupler at the lower right side of machine (Figure 31).



FIG. 31

3. Using the hose adapter, connect the squeegee hose to the wand hose (Figure 32).

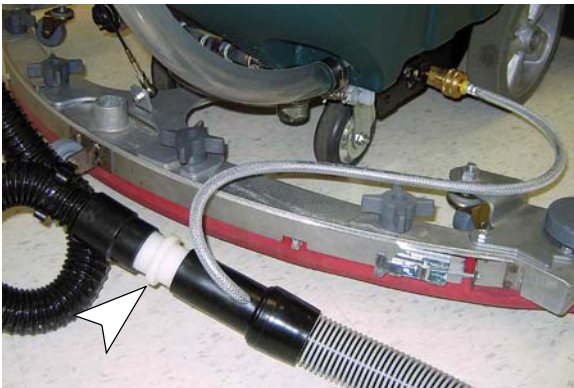

FIG. 32

4. Attach the off-aisle wand to the hoses (Figure 33).



FIG. 33

Operating the Off-Aisle Wand:

1. Turn the key and wand switch to the on (I) position (Figure 34). The FaST/ec-H2O system switch is disabled when operating the wand.



FIG. 34

2. Lower the squeegee to activate the vacuum motor (Figure 35).



FIG. 35

3. Squeeze trigger to activate solution. Use brush for scrubbing and squeegee for pickup (Figure 36).



FIG. 36

4. After scrubbing, turn off the wand switch and squeeze the trigger for five seconds to relieve the water pressure before disconnecting the solution hose.

⚠ WARNING: Fire or Explosion Hazard. Do Not Pick Up Flammable Materials Or Reactive Metals.

DRAINING AND CLEANING TANKS

After each use, the tanks should be drained and cleaned.

DRAINING RECOVERY TANK

1. Transport machine to disposal area and turn key switch off.
2. While holding the drain hose upward, remove the cap and lower hose to drain (Figure 37).



FIG. 37

3. Remove the recovery tank cover and rinse out the tank (Figure 38).



FIG. 38

4. Clean the float shut-off screen located inside the recovery tank (Figure 39).



FIG. 39

DRAINING SOLUTION TANK

1. To drain remaining water from the solution tank, pull the solution tank level hose off the hose fitting (Figure 40).



FIG. 40

2. On a monthly basis, remove the solution tank filter from underneath the machine and rinse out the screen (Figure 41). Make sure the solution tank is empty before removing filter.

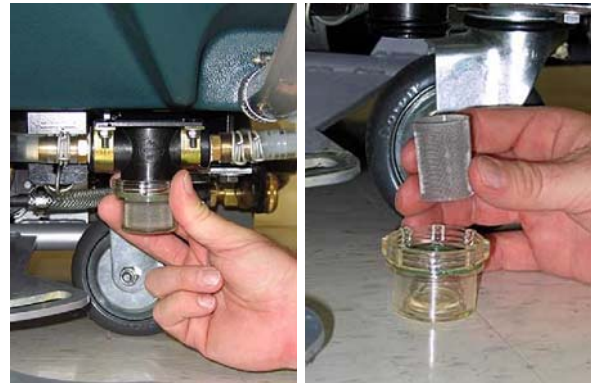

FIG. 41

OPERATION

CHARGING BATTERIES

ATTENTION: To prolong the life of the batteries only recharge the batteries if the machine was used for a total of 30 minutes or more. Do not leave batteries discharged for lengthy periods.

⚠ WARNING: Fire Or Explosion Hazard. Batteries Emit Hydrogen Gas. Keep Sparks And Open Flame Away. Keep Battery Compartment Open When Charging.

FOR SAFETY: When servicing batteries, wear protective gloves and eye protection when handling batteries and battery cables. Avoid contact with battery acid.

BATTERY CHARGER SPECIFICATIONS

- CHARGER TYPE:
 - FOR SEALED (Gel) BATTERIES
 - FOR WET (Lead acid) BATTERIES
- OUTPUT VOLTAGE - 24 VOLTS
- OUTPUT CURRENT - 20 AMPS
- AUTOMATIC SHUTOFF CIRCUIT
- FOR DEEP CYCLE BATTERY CHARGING

ON-BOARD BATTERY CHARGER SETTINGS

If your machine is equipped with the on-board charger, the charger settings must be set for your battery type before charging. Failure to properly set will result in battery damage.

To determine your battery type, see battery label. Contact your battery supplier if not specified.

To verify the setting of the charger, connect the charger cord into an electrical receptacle. The charger will display a sequence of codes. One of the codes will either read "GEL" or "Acid" (Figure 42).

GEL = Set for sealed/maintenance free batteries
Acid = Set for wet/lead acid batteries



FIG. 42

To change the setting, unplug the charger, peel up the corner of the display label and set the switches accordingly (Fig. 43). The charger cord must be unplugged when resetting.



FIG. 43

USING THE ON-BOARD BATTERY CHARGER

IMPORTANT: Before charging, make sure that the charger setting is properly set for your battery type (See ON-BOARD CHARGER SETTINGS).

1. Transport the machine to a well-ventilated area.
2. Park the machine on a flat, dry surface. Turn the key off and set the parking brake, if equipped.
3. If charging wet (lead acid) batteries check the fluid level before charging (See BATTERY MAINTENANCE).
4. Prop up the recovery tank for ventilation (Figure 44).



FIG. 44

5. Connect the charger's AC power supply cord into a properly grounded receptacle (Figure 45).

NOTE: The machine will not operate when charging.

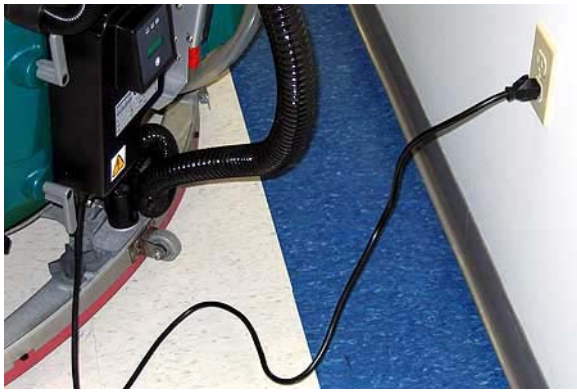

FIG. 45

6. The charger will display a sequence of codes once the cord is connected (Figure 46).

Three-digits + the following code:

A = Charging current

U = Battery voltage

h = Charging time

C = Charging ampere-hours [Ah]

E = Energy used [Kwh]

“GEL” or “Acd” = Battery type the charger is currently set for. Before charging make sure your battery type matches the display: GEL=Sealed, Acd=Wet (lead acid). To change setting, see ON-BOARD CHARGER SETTINGS.

Press the arrow button to review the codes.



FIG. 46

7. Once the charging cycle begins, the indicator lights will progress from red, yellow to green. When the green indicator light comes on, the charging cycle is done. Unplug the charger cord.

If the charger detects a problem, the charger will display an error code (See ON-BOARD BATTERY CHARGER ERROR CODES).

ON-BOARD BATTERY CHARGER ERROR CODES

DISPLAY CODE	FAULT	SOLUTION
bat	Loose or damaged battery cable	Check battery cable connections.
	Battery exceeded maximum voltage level.	No action necessary.
E01	Exceeded maximum battery voltage allowed.	No action necessary.
E02	Safety thermostat exceeded maximum internal temperature.	Check if the charger vents are obstructed.
E03	Exceeded maximum time for charging phase leaving the batteries undercharged due to a sulfated or faulty battery.	Repeat the charging cycle and if the error code E03 reappears check battery or replace it.
SCt	Safety timer exceeded maximum charging time. Interrupts charging cycle.	Replace battery.
Srt	Possible internal short circuit.	Contact Service Center.

OPERATION

USING AN OFF-BOARD BATTERY CHARGER

1. Transport the machine to a well-ventilated area.
2. Park the machine on a flat, dry surface. Turn the key off and set the parking brake, if equipped.
3. If charging wet (lead acid) batteries, check the fluid level before charging (See BATTERY MAINTENANCE).
4. Prop up the recovery tank for ventilation (Figure 47).

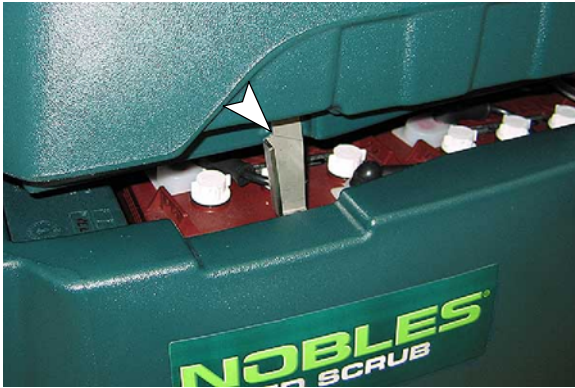

FIG. 47

5. Connect the charger's AC power supply cord into a properly grounded receptacle.
6. Connect the charger's DC cord into the machine's battery receptacle (Figure 48).



FIG. 48

7. The supplied charger will automatically begin charging and shut off when fully charged.

NOTE: The machine will not operate when charging.

ATTENTION: Do not disconnect the charger's DC cord from the machine's receptacle when the charger is operating. Arcing may result. If the charger must be interrupted during charging, disconnect the AC power supply cord first.

ADJUSTING SCRUB HEAD BRUSHES

To ensure optimum scrubbing performance periodically check the scrub head for proper adjustment.

FOR SAFETY: Before adjusting scrub head, stop machine on level surface, remove key and set parking brake if equipped.

DISK MODEL

Tools required: Measuring device, 1-1/16 in / 27 mm wrench and 15/16 in / 24mm wrench

1. With brushes installed, lower the scrub head and apply medium brush pressure.
2. Turn machine off and remove key.
3. From the center front and back of scrub head, measure the distance from the top edge of scrub head to the floor (Figure 49).



FIG. 49

4. If scrub head is not level, loosen the lock nut and turn the scrub head leveling screw to level. Tighten down the lock nut once head is level (Figure 50).



FIG. 50

CYLINDRICAL BRUSH MODEL

After installing a new set of cylindrical brushes check the brush pattern to ensure proper brush adjustment. Brushes that are not properly adjusted will result in premature wear and poor scrubbing performance (Figure 51).

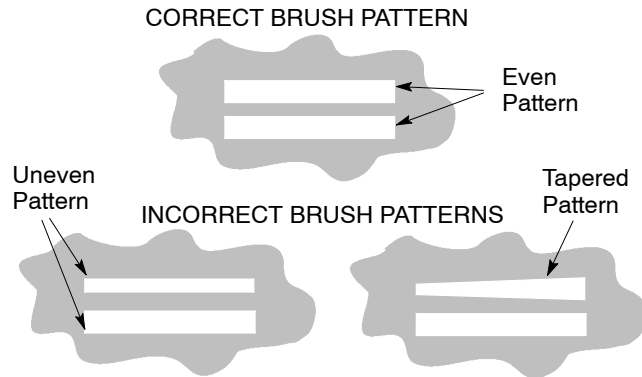

FIG. 51

To Inspect the Brush Pattern:

1. Position the machine on a dry dusty floor or apply a powdered substance, such as chalk.
2. Disconnect the drive motor wire connector to keep machine from moving forward (Figure 52).



FIG. 52

3. Lower the scrub head to the floor and apply maximum brush pressure.
4. Shut off the solution flow.
5. Pull the triggers to create a brush pattern on the floor.
6. Raise the scrub head and pull the machine away.
7. Observe the brush pattern on floor. If the brush pattern is uneven or tapered, adjustment is required.
8. Reconnect drive motor wire.

To Adjust an Uneven Brush Pattern:

Tools required: Measuring device, 1-1/16 in / 27 mm wrench and 15/16 in / 24mm wrench

1. Measure the distance from the front edge of the scrub head to the floor and from the back edge of the scrub head to the floor (Figure 53). The measurements should be the same.

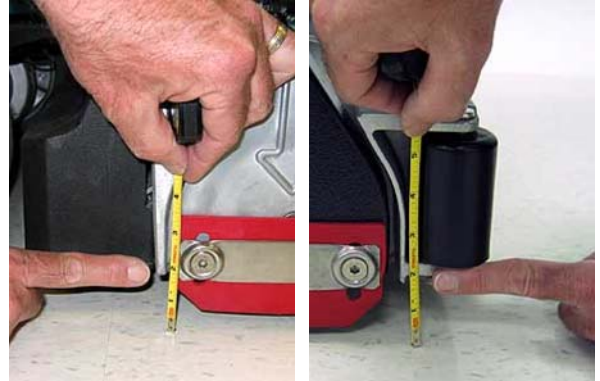

FIG. 53

2. To level the scrub head, loosen the lock nut and turn the leveling screw clockwise to lower the rear of the scrub head or counter-clockwise to lower the front (Figure 54).

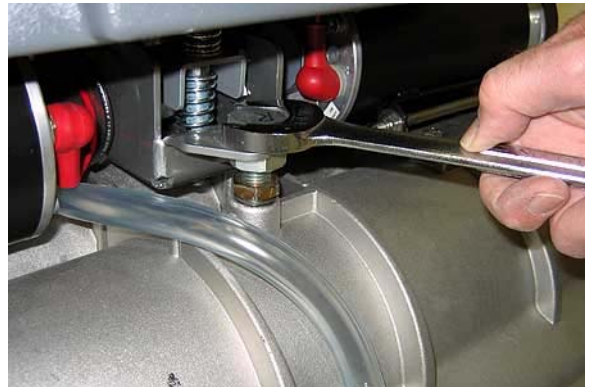

FIG. 54

3. Recheck brush pattern.

NOTE: Replace brush when bristles are worn to 5/8 in / 15 mm.

OPERATION

To Adjust a Tapered Brush Pattern:

Tools required: 3/8 in / 10mm wrench and 6mm hex wrench

1. Raise the scrub head off floor and remove key.
2. Remove the idler plate from the brush (Figure 55).



FIG. 55

3. Hold the brush plug shaft with a wrench and loosen the 6mm hex screw (Figure 56).

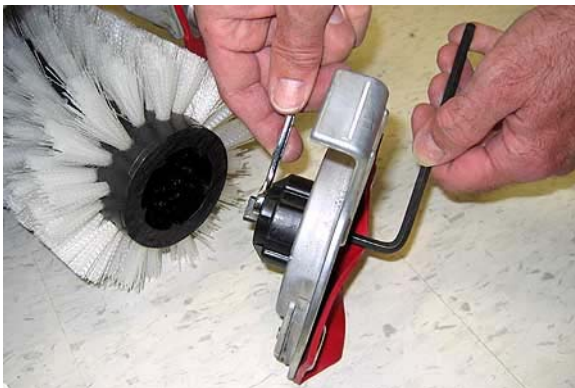

FIG. 56

4. To lower the brush end, turn the shaft clockwise for the front brush and counter-clockwise for the rear brush. Retighten hex screw (Figure 57).



FIG. 57

5. Recheck brush pattern.

NOTE: Replace brushes when bristles are worn to 5/8 in / 15 mm.

MACHINE MAINTENANCE

To keep the machine in good working condition, it's important that the following maintenance procedures are performed on a routine basis.

⚠ WARNING: Electrical Hazard. Disconnect Battery Cables Before Servicing Machine.

DAILY MAINTENANCE (After Every Use)

1. Drain the recovery tank (Figure 58).



FIG. 58

2. Rinse out the recovery tank (Figure 59).



FIG. 59

3. Remove the recovery tank float shut-off screen and clean (Figure 60).



FIG. 60

4. Drain the solution tank (Figure 61).



FIG. 61

5. Rotate pad or replace when worn (Figure 62).

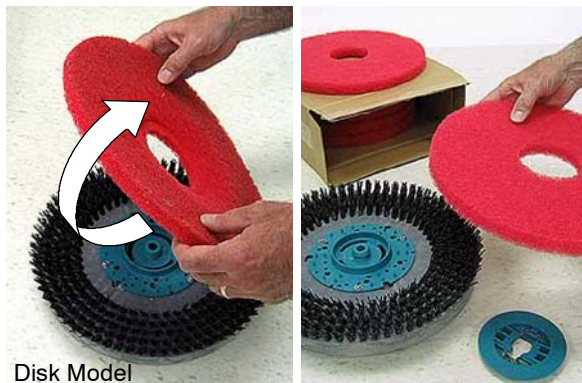

Disk Model

FIG. 62

6. Empty and rinse out the debris trough (Figure 63).

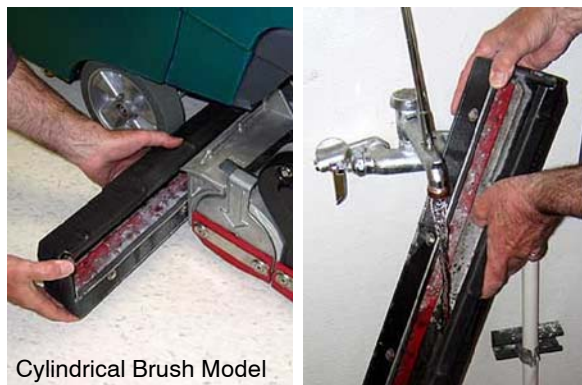

Cylindrical Brush Model

FIG. 63

7. Inspect the cylindrical brushes for wear. Rotate brushes from front-to-rear every 50 hours (Figure 64). Replace when worn to a length of 5/8 in / 15 mm.

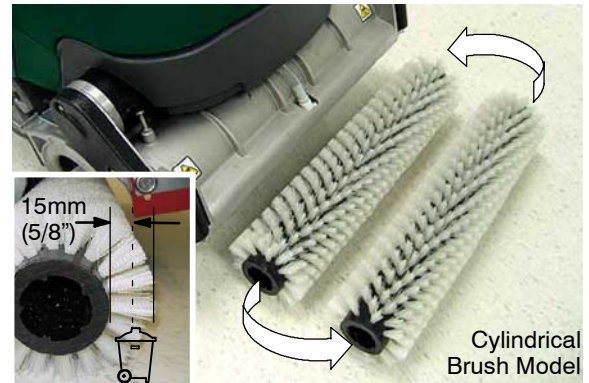
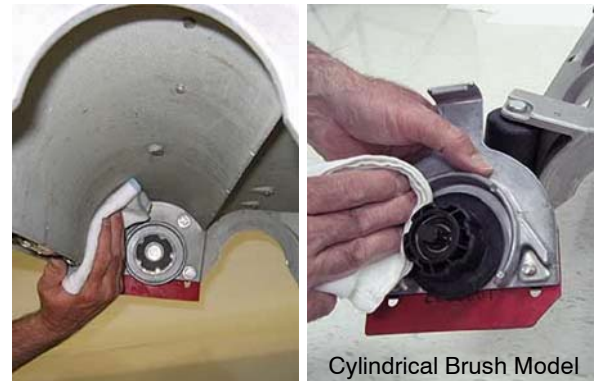

FIG. 64

8. Remove debris buildup from the underside of the cylindrical brush scrub head, including the idler plates and drive hubs (Figure 65).



Cylindrical Brush Model

FIG. 65

9. Wipe the squeegee blades clean (Figure 66). Store the squeegee assembly in the raised position to prevent blade damage.



FIG. 66

OPERATION

10. Check the condition of the squeegee blade wiping edge (Figure 67). Rotate blade if worn (See SQUEEGEE BLADES).



FIG. 67

11. Clean the machine with an all purpose cleaner and damp cloth (Figure 68).

FOR SAFETY: When cleaning machine, do not power spray or hose off machine. Electrical malfunction may occur.



FIG. 68

12. Inspect the condition of the scrub head skirt, replace if worn or damaged (Figure 69).

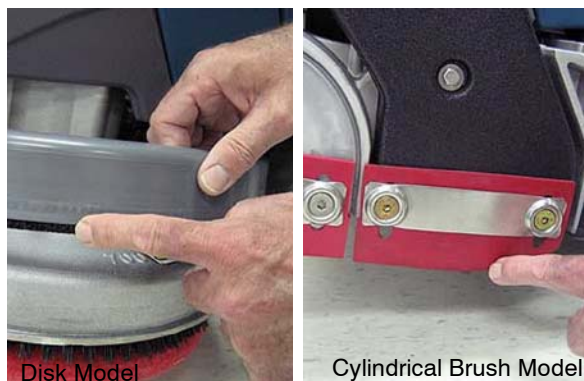

FIG. 69

13. FaST Model: Connect the FaST-PAK supply hose to the storage plug when not in use (Figure 70). Remove any dried concentrate from the hose connector by soaking it in warm water.

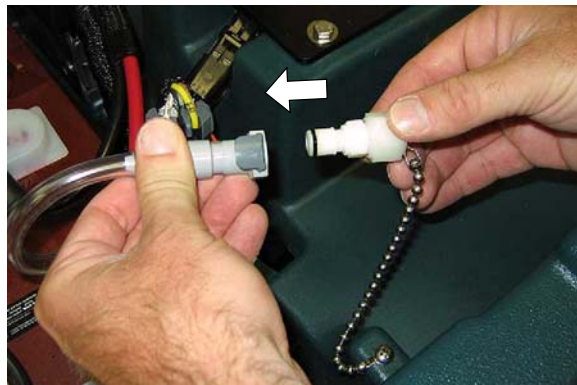

FIG. 70

14. Clean wet/lead acid batteries to prevent corrosion and check for loose battery cable connections (See BATTERY MAINTENANCE).

15. Recharge the batteries (Figure 71) after a total of 30 minutes of use or more.



FIG. 71

MONTHLY MAINTENANCE

1. Remove the solution tank filter from underneath the machine and rinse out the screen (Figure 72). Make sure the solution tank is empty before removing filter.

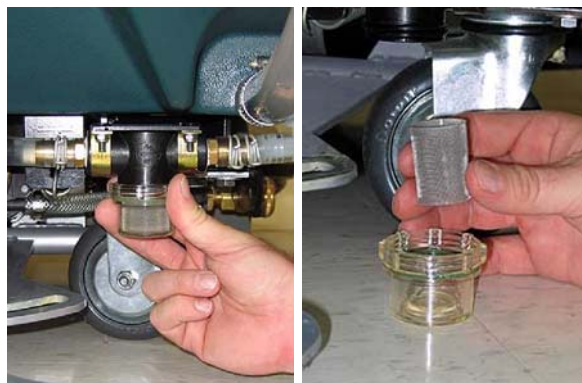

FIG. 72

- Periodically check the belt tension on the two brush motors. Tighten the belt if you're able to twist it beyond 90° at midpoint (Figure 73).

⚠ WARNING: Electrical Hazard. Disconnect Battery Cables Before Servicing Machine.

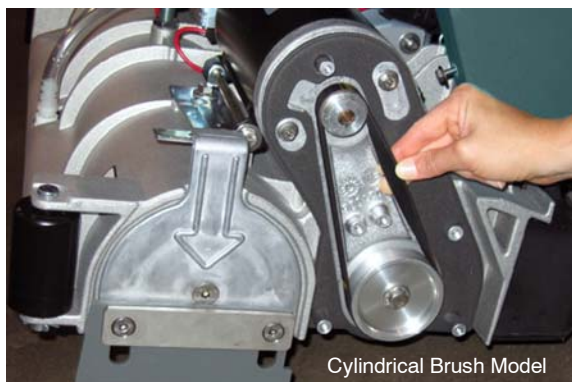

FIG. 73

- Inspect and clean the recovery tank cover seal (Figure 74). Replace if damaged.



FIG. 74

- Lubricate all pivot points and rollers with a water resistant grease.
- Lubricate the casters with a water resistant grease (Figure 75).



FIG. 75

- Clean the parking brake clamp with a cleaning solvent.
- Check the machine for loose nuts and bolts.
- Check the machine for leaks.

BATTERY MAINTENANCE (Wet/lead acid batteries)

- Check battery fluid level frequently to prevent battery damage. The fluid should be at the level shown (Figure 76). Add distilled water if low. **DO NOT OVERFILL**, the fluid may expand and overflow when charging.



CORRECT BATTERY FLUID LEVEL:

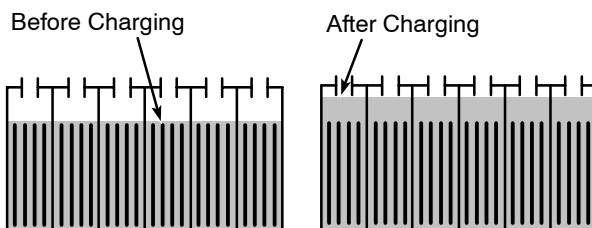

FIG. 76

⚠ WARNING: Fire Or Explosion Hazard. Batteries Emit Hydrogen Gas. Keep Sparks And Open Flame Away. Keep Battery Compartment Open When Charging.

- Clean the batteries to prevent battery corrosion. Use a scrub brush with a mixture of baking soda and water (Figure 77).

FOR SAFETY: When cleaning batteries, wear protective gloves and eye protection. Avoid contact with battery acid.



FIG. 77

OPERATION

SQUEEGEE BLADES

When the blades become worn, simply rotate the blades end-for-end or top-to-bottom to a new wiping edge. Replace blades when all edges are worn.

The front blades on the 28 in / 700 mm and 32 in / 800mm squeegee assemblies have 12/14 slots on one edge and 6 slots on the opposite edge (Figure 78). If making sharp turns with the cylindrical brush models use the 12/14 slotted edge for maximum water pickup.

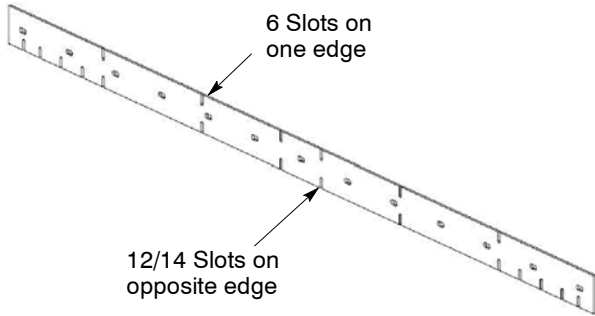

FIG. 78

Replacing Squeegee Blades:

1. Loosen the band clamp and remove the band from the squeegee assembly (Figure 79).

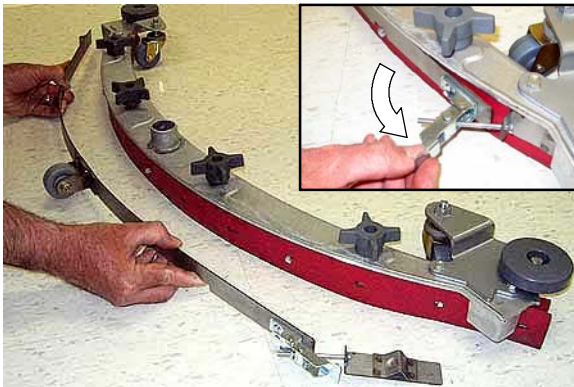

FIG. 79

2. Replace or rotate the rear blade to a new wiping edge and replace band (Figure 80).

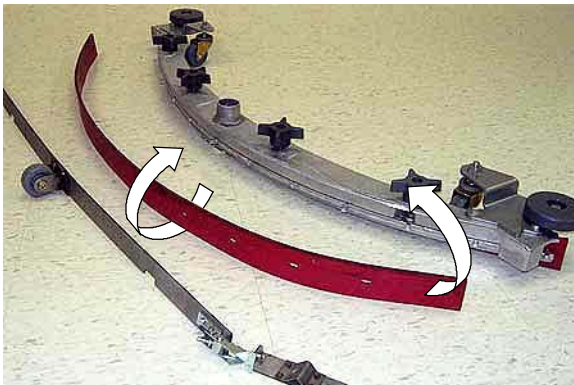

FIG. 80

3. To change the front blade, remove the band and loosen the four knobs. Replace or rotate the front blade to a new wiping edge (Figure 81)

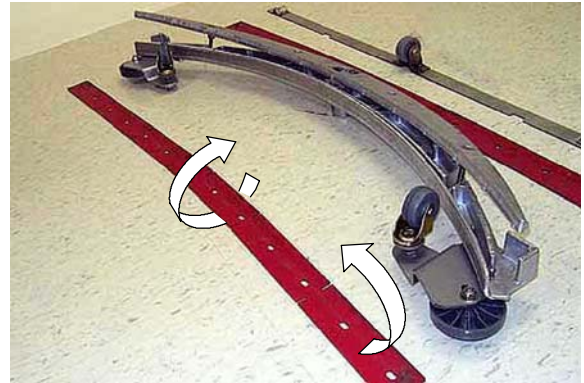

FIG. 81

MOTOR MAINTENANCE

Contact an Authorized Tennant Service Center for carbon brush replacement.

Carbon Brush Replacement	Hours
Drive Transaxle Motor	750
Vacuum Motor	
Disk Brush Motors	
Cylindrical Brush Motors	1000

⚠ WARNING: Electrical Hazard. Disconnect Battery Cables Before Servicing Machine.

FaST SYSTEM MAINTENANCE

Every 1000 hours replace the water filter and air filter located in the FaST detergent injector. Order filter kit p/n 9003009.

1. To access the detergent injector assembly, lower the scrub head and remove the front shroud (Figure 82)



FIG. 82

2. Remove the injector assembly from clamps (Figure 83).



FIG. 83

3. Replace the water and air filter. An 8mm hex wrench required to install new water filter (Figure 84).

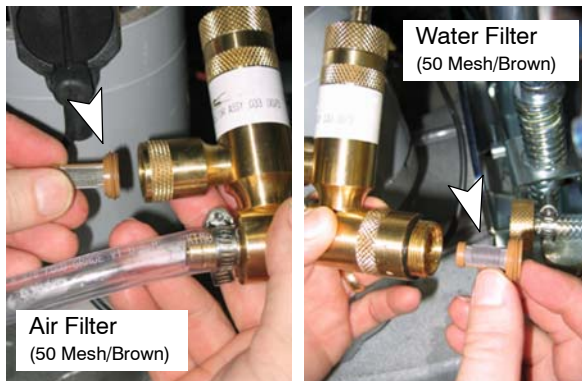

FIG. 84

ec-H2O MODULE FLUSH PROCEDURE

This procedure is only required when an alarm sounds and the ec-H2O system indicator light begins to blink red.

1. Drain the solution tank and recovery tank of all water.
2. Pour 1 gallon (4 liters) of white or rice vinegar into the solution tank at full strength. Do not dilute.

NOTE: Use *white or rice vinegar* only. The acidity level should be between 4-8%. Do not use other acids for this procedure.

FOR SAFETY: When servicing machine, wear protective gloves and eye protection when handling vinegar.

3. Disconnect the black connector fitting at the scrub head and place the hose into a bucket (Figure 85). To access the connector fitting, you may have to remove the front cover from the machine.

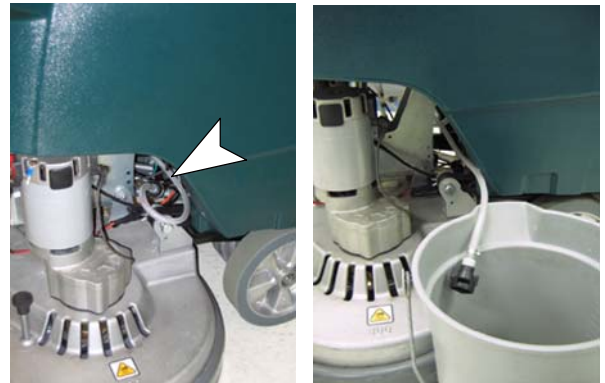

FIG. 85

4. Turn the key to the on (I) position.

OPERATION

5. Press and release the *ec-H2O* module flush switch to start the flush cycle (Figure 86). The module is located under the recover tank.

NOTE: The module will automatically shut off when the flush cycle is complete (approx. 7 minutes). The module must run the full 7 minute cycle in order to reset the system indicator light and alarm.

Repeat flush procedure if the *ec-H2O* module does not reset. If module fails to reset, contact an Authorized Service Center.

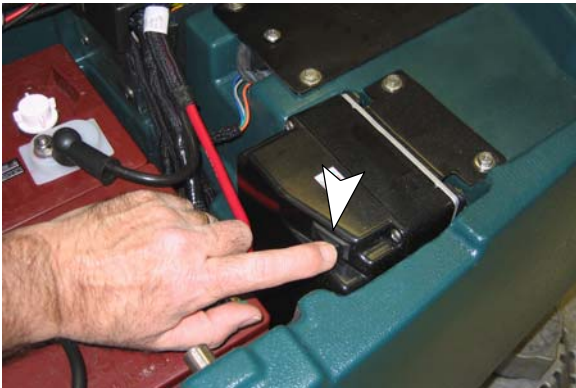

FIG. 86

JACKING UP MACHINE

Use the designated locations to jack up the machine for service (Figure 87). Empty the recovery and solution tank and position the machine on a level before jacking.

FOR SAFETY: When servicing machine, jack machine up at designated locations only. Use jack or hoist that will support machine weight.

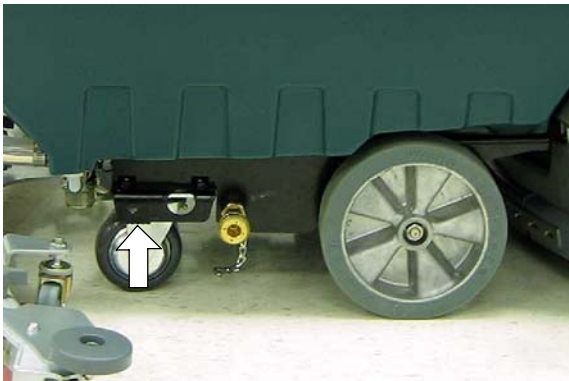

FIG. 87

TRANSPORTING MACHINE

When transporting the machine by trailer or truck, be certain to follow the transporting procedure below:

1. Drain machine tanks.
2. Load the machine using a ramp that can support the machine weight and person loading it. The maximum ramp incline should not exceed 11° at a ramp length of 3.7m (12 ft).
3. Position the front of machine up against the front of the trailer or truck. Lower the scrub head and squeegee.
4. Set the parking brake, if equipped, and place a block behind each wheel to prevent the machine from rolling.
5. Secure with tie-down straps as shown (Figure 88). It may be necessary to install tie-down brackets to trailer or truck.

FOR SAFETY: When loading/unloading machine onto/off truck or trailer, use a ramp that can support the machine weight and person loading it, do not exceed a 11° ramp incline at a ramp length of 12 ft (3.7m), use tie-down straps to secure machine and block machine wheels.

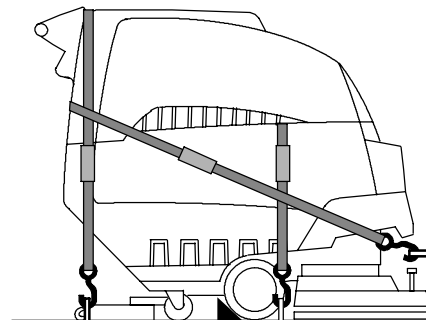

FIG. 88

STORING MACHINE

1. Charge the batteries before storing machine to prolong the life of the batteries.
2. Drain and rinse the tanks thoroughly.
3. Store the machine in a dry area with the squeegee and scrub head in the up position.
4. Open the recovery tank cover to promote air circulation.

ATTENTION: Do not expose machine to rain, store indoors.

5. If storing machine in freezing temperatures, follow the FREEZE PROTECTION instructions below.

FREEZE PROTECTION

1. Drain the solution tank and recovery tank of all water.
2. Empty the solution tank filter located under the machine (Figure 89).



FIG. 89

3. Pour 1 gallon (4 liters) of recreational vehicle (RV) antifreeze into the solution tank at full strength. Do not dilute.

FOR SAFETY: Avoid eye contact with antifreeze. Wear safety glasses.

4. Turn the machine power on and operate the solution flow system. Turn the machine off when the red RV antifreeze is visible.

If your machine is equipped with the off-aisle wand option, operate the the off-aisle wand for a few seconds to protect the pump.

Continue with the freeze protection procedure if machine is equipped with the FaST or *ec-H2O* system.

ec-H2O Model:

Press and release the flush switch on the *ec-H2O* module to cycle the antifreeze through *ec-H2O* system (Figure 90). When the antifreeze is visible, press the switch again to turn off the module.

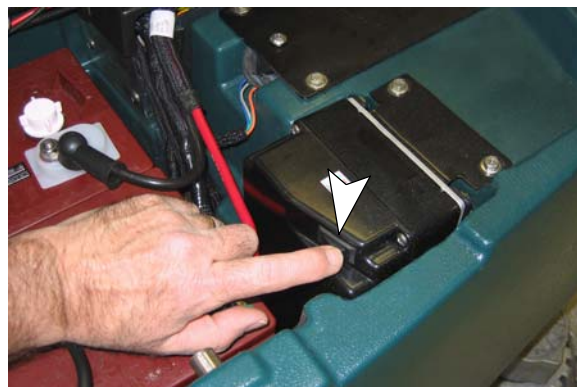

FIG. 90

IMPORTANT: Before operating machine, the antifreeze must be flushed from the module as described below.

If the antifreeze is not properly flushed from the *ec-H2O* system, the *ec-H2O* module may detect an error and not function (*ec-H2O* switch indicator light will turn red). If this occurs, reset key and repeat the flush procedure as described below.

Flushing antifreeze from *ec-H2O* module:

1. Drain the antifreeze from the solution tank into a bucket.
2. Fill the solution tank with cool water until full (See FILLING SOLUTION TANK).
3. Disconnect the black connector fitting at the scrub head and place the hose into a bucket (Figure 91). To access the connector fitting, you may have to remove the front cover from the machine.

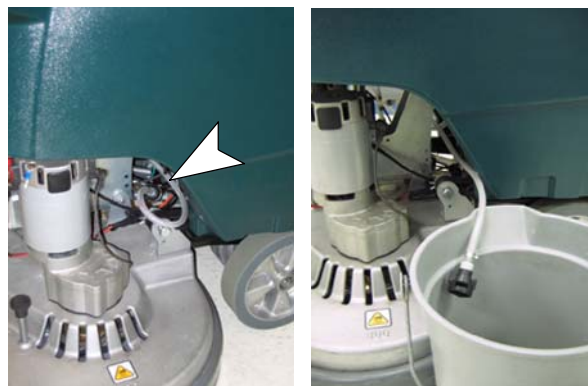

FIG. 91

4. Press and release the *ec-H2O* module switch to flush the antifreeze from the *ec-H2O* system (Figure 90). The module is located under the recovery tank.

When the water turns clear, press the module switch again to stop the flush cycle.

OPERATION

Dispose the antifreeze in an environmentally safe way according to local waste disposal regulations.

5. The machine is now ready for scrubbing.

FaST Model:

The following items are required: valve coupling #1002856 and 6 in (15 cm) hose #63182.

1. Remove the FaST-PAK carton and connect the valve coupling and 6 in (15 cm) hose to the FaST detergent supply hose (Figure 92).



FIG. 92

2. Disconnect the opposite end of the FaST supply hose from the injector assembly and drain the detergent from the hose (Figure 93). Reconnect the hose after draining. To access the injector assembly remove the front shroud.



FIG. 93

3. Pour the recreational vehicle (RV) antifreeze into the supply hose until full (Figure 94).
4. Keep the hose upright to prevent the antifreeze from spilling and lower the recovery tank.



FIG. 94

5. Operate the FaST system until the foaming stops. This step could take anywhere from 5 to 10 minutes.
6. When finished, connect the supply hose to the storage plug (Figure 95).

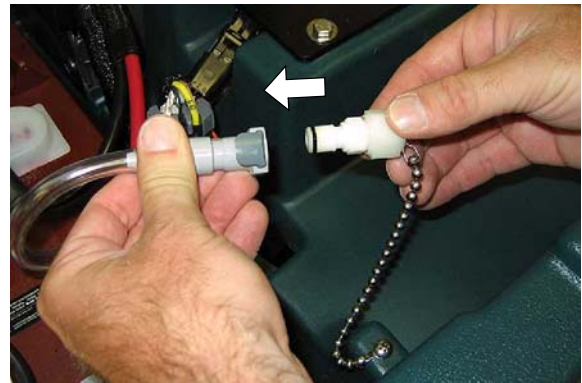

FIG. 95

7. To drain the antifreeze from the FaST supply hose, repeat steps 1 and 2.

RECOMMENDED STOCK ITEMS

Refer to the Parts List Manual for recommended stock items. Stock Items are clearly identified with a bullet preceding the parts description. See example below:

26	1017380	(00000000-) • Hose, Drain, Assy, 1.5d X 29.5l, Blk,Flx
27	1008639	(00000000-) • Drain Assy
28	1019563	(00000000-) • Strap, Drain Cap
29	1008637	(00000000-) • O Ring, 1.48" Id, 1.76" Od

TROUBLESHOOTING

PROBLEM	CAUSE	SOLUTION
Machine will not operate	Discharged batteries	Charge batteries
	Emergency-stop button activated	Turn button clockwise to reset
	Faulty battery(s)	Replace battery(s)
	Loose battery cable	Tighten loose cable
	Tripped main circuit breaker	Reset 10A main circuit breaker
	Main fuse blown	Replace 100A main fuse
	Faulty key switch	Contact Service Center
	Machine fault detected.	See Battery Meter LED Fault Codes
On-board battery charger will not operate	Plug not connected to power supply	Check plug connection
	Faulty charger fuse	Replace charger fuse
	Faulty power supply cord	Replace cord
	Error detected.	See On-board Battery Charger Error Codes
Brush motor(s) will not operate	Scrub head is raised off floor	Lower scrub head
	Battery meter lockout activated	Recharge batteries
	Discharged batteries	Charge batteries
	Tripped brush motor circuit breaker	Reset 25A circuit breaker button
	Faulty scrub head (up/down) switch	Contact Service Center
	Faulty trigger switch(es)	Contact Service Center
	Faulty brush motor or wiring	Contact Service Center
	Worn carbon brushes	Contact Service Center
	Broken or loose belt (cylindrical brush model)	Replace or tighten belt
	Faulty relay switch	Contact Service Center
Machine will not propel	Parking brake is set	Release parking brake lever
	Machine fault detected	See Battery Meter LED Fault Codes
	Propel motor fuse blown	Replace 30A fuse
	Faulty transaxle motor or wiring	Contact Service Center
	Worn carbon brushes	Contact Service Center
	Exceeded maximum incline	Avoid steep inclines and reset key
Vacuum motor will not operate	Squeegee is raised off floor	Lower squeegee
	Discharged batteries	Charge batteries
	Tripped vacuum motor circuit breaker	Reset 25A circuit breaker button
	Faulty vacuum motor or wiring	Contact Service Center
	Worn carbon brushes	Contact Service Center
Little or no solution flow	Solution tank is empty	Fill solution tank
	Clogged solution tank filter	Clean solution tank filter
	Discharged batteries	Charge batteries
	Clogged solution valve	Remove valve and clean
	Solution flow control knob set too low	Adjust solution control flow knob
	Loose screw on control knob	Calibrate knob and retighten screw.

OPERATION

TROUBLESHOOTING - Continued

PROBLEM	CAUSE	SOLUTION
Poor water pickup	Recovery tank is full or excessive foam buildup	Drain recovery tank
	Loose drain hose cap	Tighten cap
	Clogged float shut-off screen located in recovery tank	Clean screen
	Clogged squeegee assembly	Clean squeegee assembly
	Worn squeegee blades	Replace or rotate squeegee blades
	Incorrect Squeegee blade deflection	Adjust Squeegee blade height
	Loose vacuum hose connections	Secure hose connections
	Clogged vacuum hose	Remove clogged debris
	Damaged vacuum hose	Replace vacuum hose
	Recovery tank cover not in place	Properly position cover
	Damaged recovery tank cover seal	Replace seal
	Faulty vacuum motor	Contact Service Center
	Low battery charge	Recharge batteries
Poor scrubbing performance	Debris caught in brush	Remove debris
	Worn brushes/pads	Replace brushes/pads
	Incorrect brush pressure setting	Adjust pressure setting
	Wrong brush/pad type.	Use correct brush/pad
Reduced run time	Batteries not fully charged	Fully recharge batteries
	Defective batteries	Replace battery
	Batteries need maintenance	See BATTERY MAINTENANCE
	Faulty battery charger	Repair or replace battery charger
FaST Model: FaST System does not operate or operate correctly	FaST system switch is not turned on	Turn on FaST system switch
	FaST-PAK supply hose not connected	Connect supply hose
	Clogged FaST-PAK supply hose or connectors	Soak in warm water to unclog
	Empty FaST-PAK carton	Replace FaST-PAK carton
	Kink in FaST-PAK supply hose	Undo hose kink
	Clogged FaST solution system	Contact Service Center
	Faulty FaST system on/off switch	Contact Service Center
	Faulty pump	Contact Service Center
	Clogged solution tank filter	Drain solution tank. Remove solution tank filter, clean and reinstall
	Clogged detergent orifice/filter screen	Replace orifice/filter screen (See FaST SYSTEM MAINTENANCE)
	Clogged FaST solution inlet filter	Contact Service Center
FaST Pump fuse blown	Replace 7.5A fuse	

TROUBLESHOOTING - Continued

PROBLEM	CAUSE	SOLUTION
ec-H2O Model: ec-H2O system indicator light blinking red	Mineral deposit build-up in module	Flush module (See <i>ec-H2O</i> MODULE FLUSH PROCEDURE)
ec-H2O Model: alarm sounds		
ec-H2O Model: ec-H2O system indicator light solid red	Defective module	Contact Service Center
ec-H2O Model: ec-H2O system indicator light does not turn on	Defective light or module	Contact Service Center
ec-H2O Model: No water flow	Clogged module	Contact Service Center
	Defective solution pump	Replace solution pump

BATTERY METER LED FAULT CODES

CODE (Flashing LED Bars)	FAULT	SOLUTION
One	Low voltage shut-off. Scrubbing function stops.	Recharge batteries.
		Check battery connection.
Two	Battery charge level getting low.	Recharge batteries.
Three	Drive motor tripped.	Remove overload condition and reset key.
	Short circuit to drive motor.	Contact Service Center.
Four	Battery lockout.	Recharge batteries immediately.
Eight	Controller tripped.	Contact Service Center.
Ten	High battery voltage reading.	Check battery connections.
No Bars	Sleep mode.	Turn key to restore.
Bars Rippling	Throttle engaged at start up.	Release triggers.

OPERATION

MACHINE SPECIFICATIONS

MODEL	Disk, 24 in / 600mm	Disk, 28 in / 700mm	Disk, 32 in / 800mm	Cylindrical, 26 in / 650mm	Cylindrical, 32 in / 800mm
LENGTH	53.4 in / 1,357 mm	55.5 in / 1,408 mm	58 in / 1,471 mm	55 in / 1,399 mm	55 in / 1,399 mm
WIDTH	25.4 in / 645 mm	29 in / 737 mm	33 in / 838 mm	28 in / 711 mm	34 in / 864 mm
HEIGHT	44 in / 1120 mm				
MINIMUM AISLE TURN	53 in / 1,346 mm	59 in / 1,499 mm	64 in / 1,626 mm	62 in / 1,575 mm	64.5 in / 1,638 mm
WEIGHT	293 lb / 133 kg	320 lb / 145 kg	332 lb / 151 kg	332 lb / 151 kg	342 lb / 155 kg
WEIGHT WITH BATTERIES	569 lb / 258 kg	593 lb / 269 kg	606 lb / 275 kg	606 lb / 275 kg	615 lb / 279 kg
RECOVERY TANK CAPACITY	27 gal / 105 L				
SOLUTION TANK CAPACITY	22.5 gal / 85 L				
DRIVE SYSTEM	Transaxle, 24 V, .25 hp / .19 kW				
TRAVEL SPEED, MAXIMUM	Cleaning: 220 ft / 67 m per min Transporting: 235 ft / 72 m per min				
PRODUCTIVITY RATE Theoretical	26,400 ft ² / 2,450 m ² h	30,800 ft ² / 2,860 m ² h	35,200 ft ² / 3,270 m ² h	28,600 ft ² / 2,660 m ² h	35,200 ft ² / 3,270 m ² h
PRODUCTIVITY RATE Estimated Actual	17,875 ft ² / 1,660 m ² h	20,800 ft ² / 1,930 m ² h	24,000 ft ² / 2,230 m ² h	19,200 ft ² / 1,785 m ² h	24,000 ft ² / 2,230 m ² h
CLEANING PATH WIDTH	24 in / 600 mm	28 in / 700 mm	32 in / 800 mm	26 in / 650 mm	32 in / 800 mm
BRUSH DIAMETER	11.9 in / 302 mm	13.9 in / 353 mm	15.9 in / 404 mm	5.9 in / 151 mm	5.9 in / 151 mm
BRUSH PRESSURE	up to 120 lb / 54 kg				
SOLUTION FLOW RATE	.5 gpm / 1.89 L/min	.50 gpm / 1.89 L/min		.6 gpm / 2.27 L/min	.6 gpm / 2.27 L/min
SQUEEGEE WIDTH	35.7 in / 908 mm standard	41.3 in / 1,051 mm standard	46.6 in / 1,185 mm standard	41.3 in / 1,051 mm standard	46.6 in / 1,185 mm standard
	31.5 in / 800 mm narrow aisle	35.7 in / 908 mm narrow aisle	41.3 in / 1,051 mm narrow aisle	35.7 in / 908 mm narrow aisle	41.3 in / 1,051 mm narrow aisle
BRUSH MOTOR	Qty 2, .75 hp / .55 kW, 220 rpm, 24 V, 29 A			Qty 2, .63 hp / .47 kW, 1500 rpm, 24 V, 23 A	
VACUUM MOTOR	.85 hp / .63 kW, 640 W, 3-stage 5.7, 24 V, 26 A				
WATER LIFT - AIR FLOW	62 in / 55 mm - 69 ft ³ / 32.4 L ³ /m				
BATTERIES	Qty 4, 6 V				
BATTERY CAPACITY	WET (lead Acid) = 235 Ah @ 20 h rate Sealed (Gel) = 200 Ah @ 20 h rate				
RUN TIME PER CHARGE*	WET = Up to 5.0 hours Gel = Up to 4.0 hours				
ON-BOARD CHARGER	120 VAC, 10 A, 50/60 Hz, 24 VDC, 20 A output				
TOTAL POWER CONSUMPTION	50 A nominal				
VOLTAGE DC	24 VDC				
PROTECTION GRADE	IPX3				
DECIBEL RATING AT OPERA- TOR'S EAR, INDOORS.**	67dBA			68dBA	
VIBRATION AT CONTROLS	<.39 ft/s ² / <.1188 m/s ²			<.34 ft/s ² / <.103 m/s ²	
ACCELERATION RATE ON OPERATOR - MAX.	.56 ft / .179 m /s ²				
GRADE LEVEL, MAX.	Scrubbing 5% (3°), Transporting 8% (5°)				

* Run times are based on Continuous Scrubbing Run Times.

** Sound levels (ISO 11201) as recommended by the American Association of Cleaning Equipment Manufacturers (AACEM) and OSHA.

FaST SYSTEM	Disk, 24 in / 600mm	Disk, 28 in / 700mm	Disk, 32 in / 800mm	Cylindrical, 26 in / 650mm	Cylindrical, 32 in / 800mm
PRODUCTIVITY RATE Estimated Actual	20,075ft ² / 1,865m ² /h	22,750ft ² / 2,115m ² /h	26,250ft ² / 2,440m ² /h	21,000ft ² / 1,950m ² /h	26,250ft ² / 2,440m ² /h
SOLUTION PUMP	24 Volt DC, 3.5 A, 1.5 gpm / 5.6 L/min open flow, 60 psi / 4.13 Bar bypass setting				
SOLUTION FLOW RATE	0.15 gpm / 0.57 L/min	0.22 gpm / 0.83 L/min.		0.15 gpm / 0.57 L/min.	0.22 gpm / 0.83 L/min.
CONCENTRATE FLOW RATE	0.0193oz / 0.57CC /min.	0.028oz / 0.83CC /min.		0.0193oz / 0.57CC /min.	0.028oz / 0.83CC /min.
CONCENTRATE TO WATER DILUTION RATIO	1:1000				
ec-H₂O SYSTEM					
ec-H₂O SYSTEM	Disk, 24 in / 600mm	Disk, 28 in / 700mm	Disk, 32 in / 800mm	Cylindrical, 26 in / 650mm	Cylindrical, 32 in / 800mm
PRODUCTIVITY RATE Estimated Actual	20,075ft ² / 1,865m ² /h	22,750ft ² / 2,115m ² /h	26,250ft ² / 2,440m ² /h	21,000ft ² / 1,950m ² /h	26,250ft ² / 2,440m ² /h
SOLUTION PUMP	24 Volt DC, 3.5 A, 1.5 gpm / 5.6 L/min open flow, 60 psi / 4.13 Bar bypass setting				
SOLUTION FLOW RATE *	0.15 gpm / 0.57 L/min (standard)	0.22 gpm / 0.83 L/min (standard)		0.22 gpm / 0.83 L/min (standard)	0.33 gpm / 1.25 L/min (standard)
	0.22 gpm / 0.83 L/min (optional)	0.33 gpm / 1.25 L/min (optional)		0.30 gpm / 1.10 L/min (optional)	0.44 gpm / 1.66 L/min (optional)
	0.30 gpm / 1.10 L/min (optional)	0.44 gpm / 1.66 L/min (optional)			

* If the optional solution flow rates are required, contact an Authorized Service Center.

MACHINE DIMENSIONS

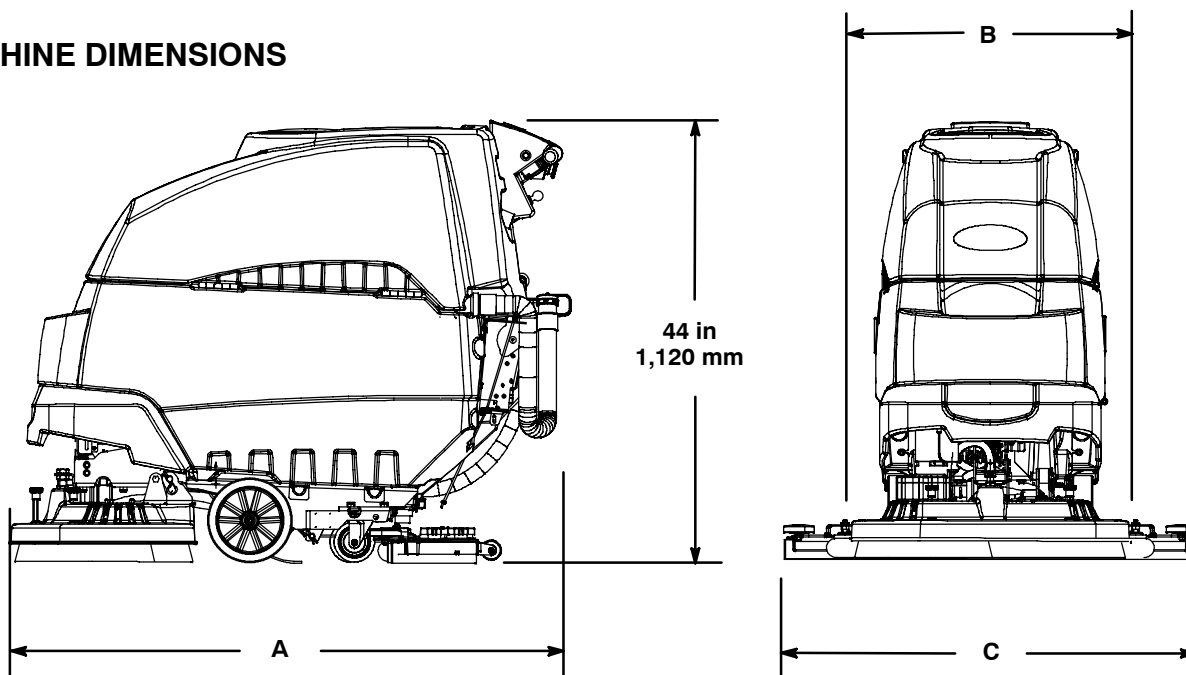

Models:	24 in / 600 mm Disk	28 in / 700 mm Disk	32 in / 800 mm Disk	26 in / 650 mm Cylindrical	28 in / 800 mm Cylindrical
A =	53.4 in / 1,357 mm	55.5 in / 1,408 mm	58 in / 1,471 mm	55 in / 1,399 mm	55 in / 1,399 mm
B =	25.4 in / 645 mm	29 in / 737 mm	33 in / 838 mm	28 in / 711 mm	34 in / 864 mm
C =	35.7 in / 908 mm	41.3 in / 1,051 mm	46.6 in / 1,185 mm	41.3 in / 1,051 mm	46.6 in / 1,185 mm